

BATTERY CABINET KEOR DK R/T 5-6-10 kVA

Installation and Maintenance Manual

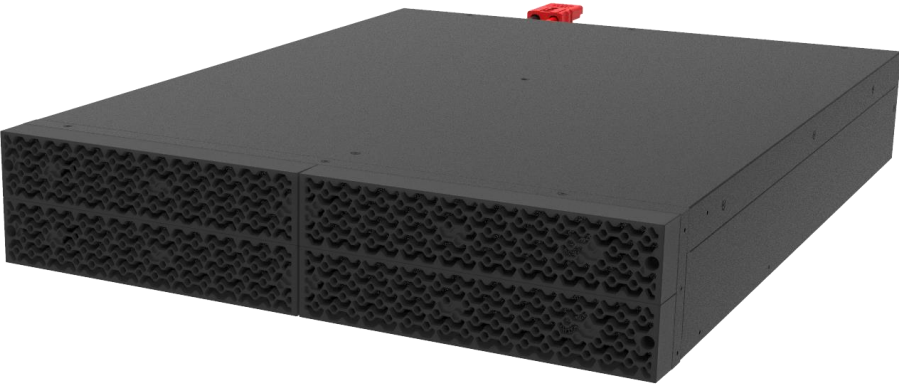



Table of Contents

1.	Introduction	4
1.1	General remarks.....	4
1.2	Manufacturer's liability and guarantee	5
1.2.1	Guarantee terms	5
1.2.2	Extension of the guarantee and maintenance contracts	6
1.3	Copyright.....	6
2.	Regulatory and safety requirements	7
2.1	Definitions of “Skilled Technician” and “Operator”	7
2.1.1	Skilled Technician	7
2.1.2	Operator	8
2.2	Personal Protective Equipment	8
2.3	Hazard signs in the workplace	9
2.4	Signs on the equipment.....	9
2.5	Batteries	10
2.6	Installation and maintenance.....	10
3.	Equipment check and transportation	12
3.1	Visual check	12
3.2	Equipment check.....	12
3.3	Transportation	13
3.4	Positioning constraints.....	13
4.	Installation.....	14
4.1	Rear Panel	14
4.2	Mechanical Installation	15
4.2.1	Tower installation.....	15
4.2.2	Rack mount installation	15
4.4	Electrical connection	16
4.4.1	Wiring operation	16
5.	Maintenance	18
5.1	Preventive maintenance	18
5.2	Periodical checks	18
5.3	Ordinary maintenance	19
5.3.1	EBC replacement	19
5.3.2	Battery replacement	19
6.	Warehousing	21
6.1	Batteries	21
7.	Dismantling	22

7.1	Battery disposal.....	22
7.2	Electronic component dismantling.....	22
8.	Technical characteristics.....	23

1. Introduction

 The instructions in this manual are intended for a **SKILLED TECHNICIAN** (paragraph 2.2.1) to provide information on how to install and maintain the battery cabinet of the Keor DK R/T series.

 You can download the full manual from the UPSservice App.



1.1 General remarks

The purpose of this manual is to provide to the skilled technician:

- instructions to safely install the Keor DK R/T battery cabinet, also called only “battery cabinet”, “EBC” (External Battery Cabinet) or “equipment” in the rest of the manual.
- information to carry out ordinary maintenance procedures. Extraordinary maintenance operations are not dealt with because they are the sole preserve of the LEGRAND Technical Support Service.

The manual refers to laws, directives, and standards that the skilled technician is required to be aware of and consult. It does not substitute the skill of technical personnel who must have received adequate preliminary training.

The intended use and configurations envisaged for the equipment as shown in this manual are the only ones allowed by LEGRAND (also called “Manufacturer” in the rest of the manual).

Any other use or configuration must be previously agreed with the Manufacturer in writing and the written agreement will become part of the installation and user manuals.

This manual is not a specification; therefore, LEGRAND reserves the right to make any changes to data without prior notice. It also complies with the directives and standards in force at the time of its release. The version of the manual updated to its latest release is available at ups.legrand.com.

The original text of this publication, drafted in English, is the only reference for the resolution of disputes of interpretation linked to translations into other languages.

Some operations are shown in graphic symbols that draw the attention of the reader to the danger or the importance they imply:



This symbol indicates a danger entailing a high degree of risk that, if not avoided, will lead to death or severe injury or considerable damage to the equipment, people, and things around it.



This symbol indicates a danger entailing a level of risk that, if not avoided, could lead to minor or moderate injury or material damage to the equipment, people, and things around it.



This symbol indicates essential information which should be read carefully.

The manual must be kept in a safe, dry place and must always be available for its entire lifetime. It is recommended to make a copy of it and file it away. In case of need (for example in case of damage that even partially compromises its consultation) the skilled technician is required to get a new copy from the Manufacturer.

If information is exchanged with the Manufacturer or the authorized assistance personnel, it is essential to refer to the equipment's rating plate data and serial number.

1.2 Manufacturer's liability and guarantee

The skilled technician and the operator shall scrupulously comply with the precautions and installation instructions indicated in the manuals. They must:

- always work within the operating limits of the equipment.
- always carry out constant and careful maintenance through a skilled technician who complies with all the procedures indicated in the installation and maintenance manual.

The Manufacturer declines all indirect or direct responsibility arising from:

- assembly and cabling made by personnel not fully qualified according to national standards to work on equipment presenting electrical hazards.
- assembly and cabling made without using safety equipment and tools required by national safety standards.
- failure to observe the installation and maintenance instructions and use of the equipment which differs from the specifications in the manuals.
- use by personnel who have not read and thoroughly understood the content of the user manual.
- use that does not comply with the specific standards used in the country where the equipment is installed.
- modifications made to the equipment, software, functioning logic unless they have been authorized by the Manufacturer in writing.
- repairs that have not been authorized by the LEGRAND Technical Support Service.
- damage caused intentionally, through negligence, by acts of God, natural phenomena, fire or liquid infiltration.
- damage caused using batteries and protections not specified in the manual.
- accidents caused by a wrong assembly of the safety protections or due to the lack of application of the safety labels.

The transfer of the equipment to others also requires handing over all the manuals. Failure to do it will automatically nullify any right of the buyer, including the terms of the guarantee where applicable.

If the equipment is sold to a third party in a country where a different language is spoken, the original owner shall be responsible for providing a faithful translation of this manual in the language of the country where the equipment will be used.

1.2.1 Guarantee terms

The guarantee terms may vary depending on the country where the UPS is sold. Check the validity and duration with LEGRAND's local sale representative.

If there should be a fault in the product, contact the LEGRAND Technical Support Service which will provide all the instructions on what to do.

Do not send anything back without LEGRAND's prior authorization.

The guarantee becomes void if the UPS has not been brought into service by a properly trained skilled technician (see paragraph 2.2.1).

If during the guarantee period the UPS does not conform to the characteristics and performance laid down in this manual, LEGRAND at its discretion will repair or replace the UPS and relative parts. All the repaired or replaced parts will remain LEGRAND's property.

LEGRAND is not responsible for costs such as:

- losses of profits or earnings.
- losses of equipment, data or software.
- claims by third parties.
- any damage to persons or things due to improper use, unauthorized technical alterations or modifications.
- any damage to persons or things due to installations where the full compliance with the standard regulating the specific usage applications have not been guaranteed.

1.2.2 Extension of the guarantee and maintenance contracts

The standard guarantee can be consolidated in a single extension contract (maintenance contract).

Once the guarantee period has passed, LEGRAND is available for giving a technical assistance service able to meet all requirements, maintenance agreements, 24/7 availability and monitoring.

Please, contact the LEGRAND Technical Support Service for further information.

1.3 Copyright

The information contained in this manual cannot be disclosed to any third party. Any partial or total duplication of the manual by photocopying or other systems, including electronic scanning, which is not authorized in writing by LEGRAND, violates copyright conditions and may lead to prosecution.

2. Regulatory and safety requirements

 Before carrying out any operation on the equipment, it is necessary to read the entire manual carefully, especially this chapter. Look after this manual carefully and consult it repeatedly during installation and maintenance by a skilled technician.



The equipment has been made for the applications given in the manual. It may not be used for purposes other than those for which it has been designed or differently from those specified in this manual. The various operations must be carried out according to the criteria and the chronology described in this manual.



Do not disable any safety, notification or warning device and do not ignore any alarm, warning message or notice, no matter whether they are generated automatically or represented by signs fixed to the equipment.



In case of emergency, follow the regulations in force in the country where the equipment is installed.

2.1 Definitions of “Skilled Technician” and “Operator”

2.1.1 Skilled Technician

The professional that will carry out the installation, start up and ordinary maintenance is called “Skilled Technician”.

This definition refers to people qualified by LEGRAND who have the specific technical qualification and are aware of the method of installing, assembling, repairing, bringing online and using the equipment safely.

In addition to the requirements listed in the paragraph below for a general operator, the Skilled Technician is qualified according to national safety standards to work under dangerous electrical voltage and uses the personal protective equipment required by national safety standards for all the operations indicated in this manual (see the examples listed in paragraph 2.3).

 The safety manager is responsible for protection and company risks prevention according to what is indicated in European directives 2007/30/EC and 89/391/EEC regarding safety in the workplace. The safety manager must ensure that all the people working on the equipment have received all the instructions concerning them in the manual, especially those contained in this chapter.

2.1.2 Operator

The professional assigned to the equipment for normal use is called "Operator".

This definition refers to people who know how to operate the equipment defined in the user manual and have the following requisites:

1. technical education, which enables them to operate according to safety standards in relation to the dangers linked to the presence of electric current.
2. training on the use of personal protective equipment and basic first aid interventions.

When choosing an operator, the company safety manager must consider

- the person's work fitness according to the laws in force.
- the physical aspect (not disabled in any way).
- the psychological aspect (mental stability, sense of responsibility);
- the educational background, training and experience.
- the knowledge of the standards, regulations and measures for accident prevention.

He shall also provide training in such a way as to provide thorough knowledge of the equipment and its component parts.

Some typical activities the operator is expected to carry out are:

- the use of the equipment in its normal functioning state and the restore of the functioning after it shuts down.
- the adoption of the necessary provisions for maintaining the quality performance of the UPS.
- the cleaning the equipment.
- cooperation with personnel responsible for ordinary maintenance activities (Skilled Technicians).

2.2 Personal Protective Equipment



The UPS poses a considerable risk of electric shocks and a high short circuit current. During installation, use and maintenance operations, the equipment mentioned in this section must be used.



People responsible for operating this equipment and/or passing close to it must not wear garments with flowing sleeves, nor may laces, belts, bracelets or other metal pieces that might cause a danger.

The following list sum up the minimum Personal Protective Equipment to wear always. Additional requirements may be needed according to national safety standards.



Anti-accident and non-sparking shoes with rubber sole and reinforced toe



Protective gloves for handling operations



Isolated rubber gloves for operations of connection and work under hazardous voltage



Protective garments for electrical work



Protective face and head shield



Isolated tools



The skilled technician must work on electrical insulated carpet, and he must not wear any kind of metal objects like watches, bracelets, etc.

2.3 Hazard signs in the workplace

The following signs must be exhibited at all points of access to the room where the equipment is installed:



Electric current
This sign indicates electrical live parts.



How to proceed in an emergency
Do not use water to quench fires but only extinguishers designed for putting out fires in electrical equipment.



No smoking
This sign indicates that smoking is not allowed.

2.4 Signs on the equipment

Safety signs are displayed on the UPS to communicate warning message about potential dangers. Strictly comply with those instructions. Removing these signs and/or working by ignoring those warnings is prohibited.

Contact the Manufacturer if a sign deteriorates and/or it is no longer legible, even if only partially.



Potential risks can be drastically reduced by wearing the Personal Protective Equipment listed in this chapter, which are indispensable. Always operate with due care around dangerous areas marked by the appropriate warning notices on the equipment.

2.5 Batteries



The UPS is powered by its own DC energy source (batteries). The output terminals may have a dangerous voltage even if the UPS is not connected to the AC power network.

Disconnect all external battery cabinets before performing any installation and/or maintenance operation.



A battery can present a risk of electrical shock and burns by high short-circuit circuit current. Failed batteries can reach temperatures that exceed the burn thresholds for touchable surfaces. The following precautions should be observed when working on batteries:

- a) remove watches, rings or other metal objects.
- b) use tools with insulated handles.
- c) wear rubber gloves and boots.
- d) do not lay tools or metal parts on top of batteries.
- e) disconnect the charging source prior to connecting or disconnecting battery terminals.
- f) determine if battery is inadvertently grounded. If inadvertently grounded, remove source from ground. Contact with any part of a grounded battery can result in electrical shock. The likelihood of such shock can be reduced if such grounds are removed during installation and maintenance (applicable to equipment and remote battery supplies not having a grounded supply circuit).
- g) never leave live cable terminals without an insulated protection.
- h) When replacing batteries, replace with the same type and number of batteries or battery packs. There is the risk of explosion if batteries are replaced by an incorrect type.

Do not dispose of batteries in a fire. The batteries may explode.

Do not open or mutilate batteries. Released electrolyte is harmful to the skin and eyes. It may be toxic. The batteries installed inside the cabinet must be disposed of correctly. For the disposal requirements refer to local laws and relevant standards.



The UPS must not be turned on if liquid is leaking from the batteries.



Do not open any battery breaker while the UPS is powering the loads in stored energy mode.

2.6 Installation and maintenance



Any installation or maintenance operation must be done only after the equipment has been disconnected from any source of power. Check there is no live voltage.

All remote switch disconnectors must be locked with an appropriate padlock to make sure no one will turn them on.



To reduce the risk of fire or electric shock, the UPS and its battery cabinet must work in closed, clean environments with controlled temperature and humidity. It must be kept away from water and any inflammable liquids and corrosive substances. The room temperature must not be above +40°C (+104°F) and the relative humidity must be a maximum of 95% not condensing.



Do not run the equipment with fixed protections not installed (panels etc.). In case of breaking, buckling or malfunctioning of the equipment or parts of it, repair or replace immediately.



The equipment and workplace must be kept completely clean. Do not use oils or chemical products for cleaning because they could scratch, corrode or damage certain parts of the equipment. Upon completion of the installation/maintenance operations, before connecting the power supply, carefully check that no tools and/or material of any kind have been left next to the equipment. Depositing flammable material near the equipment is forbidden.



While maintenance operations are being carried out, "Maintenance work in progress" signs must be affixed in the department in such a way that they can be easily seen from any access area.

3. Equipment check and transportation

3.1 Visual check

Carefully inspect the packaging and the equipment for any damage that might have occurred during transport.

If there is possible or ascertained damage, immediately inform:

- the transporter and the shipping company.
- the LEGRAND Technical Support Service.

Check that the equipment corresponds with the items indicated in the delivery documentation.

If the UPS must be stored, follow the instructions of chapter 7.



Mechanical damage to the electrical components constitutes a danger to persons and property. In case of doubt regarding the non-integrity of the package or of the product contained therein, contact the manufacturer before carrying out the installation and/or the start-up.

3.2 Equipment check

The equipment and the relative supplied accessories must be in perfect conditions.

Check that:

- the shipping data (address of the recipient, no. of packages, order no, etc.) correspond to what is contained in the delivery documentation.
- the technical rating plate data on the label applied to the battery cabinet correspond with the material described in the delivery documentation.
- the documentation accompanying the equipment includes the installation and user manuals.

In case of discrepancy, immediately inform the LEGRAND Technical Support Service before commissioning the equipment.

The content of the supply is subject to thorough checking before the shipment. Nonetheless it is always advisable to check that it is complete and in order on receiving the material.

The following list is general:

- 1 battery cabinet.
- installation and maintenance manual.
- accessory kit:

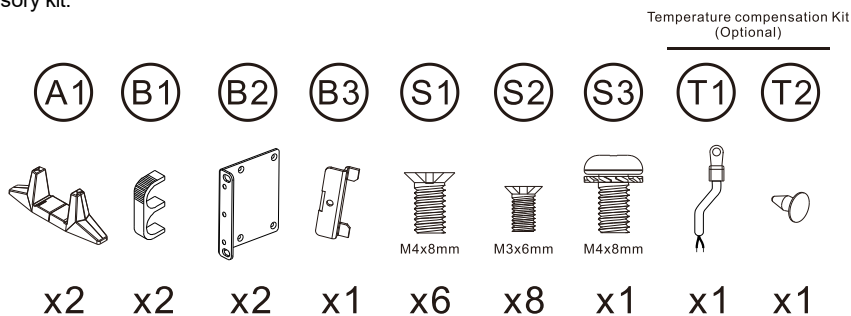

 In case of defects and/or missing items, immediately inform the LEGRAND Technical Support Service before commissioning the equipment.

3.3 Transportation



Avoid turnover during the transport of the EBC. Cabinets must always be handled in upright position. During loading and unloading operations, always respect the indications marked on the package.



Avoid bending or deforming the components and altering the insulation distances while transporting and handling the product.



Do not ship the equipment along with any inflammable, explosive, corrosive item. Do not expose the package to rain or other adverse climatic conditions.



The equipment must always be handled by trained and instructed personnel. Comply with the safety regulations in force in your country relative to the usage of lifting equipment and/or accessories.

3.4 Positioning constraints

Keep good ventilation around the EBC. The clearance between any adjacent devices or wall should be at least 200 mm. Poor ventilation can reduce the service life of inner components and affect the life span of the EBC.

Since the battery cabinet is heavy, it must be installed in a location that can support its weight.

4. Installation

 All EBC installation operations must be carried out exclusively by a **SKILLED TECHNICIAN** qualified and authorized by **LEGRAND** (paragraph 2.2.1).

 Strictly follow the safety regulations and instructions provided in the manual of the UPS Keor DK R/T.

4.1 Rear Panel

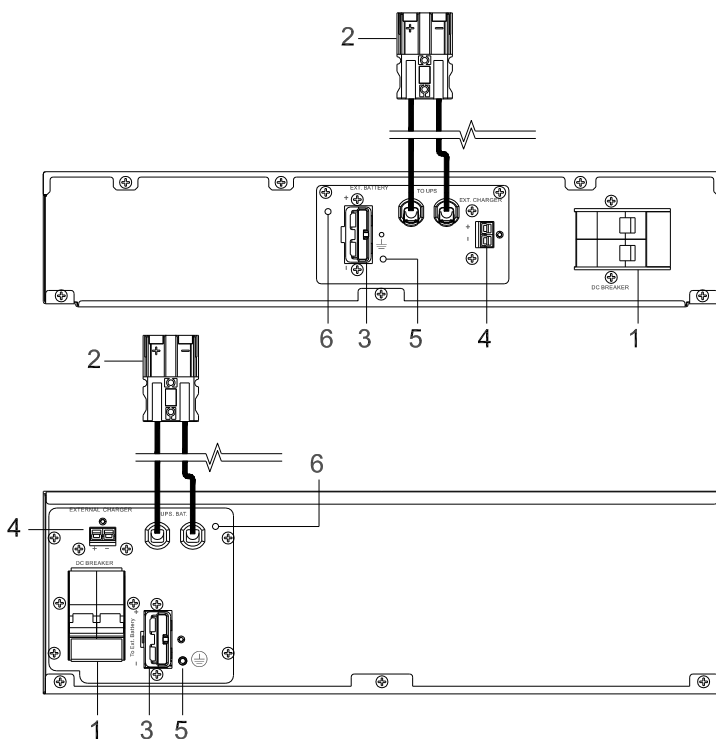

1. DC breaker
2. DC power cord
3. Battery connector
4. External charger port
5. Grounding
6. Temperature compensation

4.2 Mechanical Installation

4.2.1 Tower installation

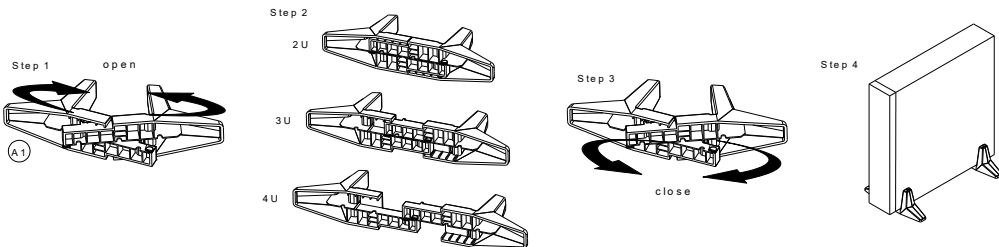

4.2.2 Rack mount installation

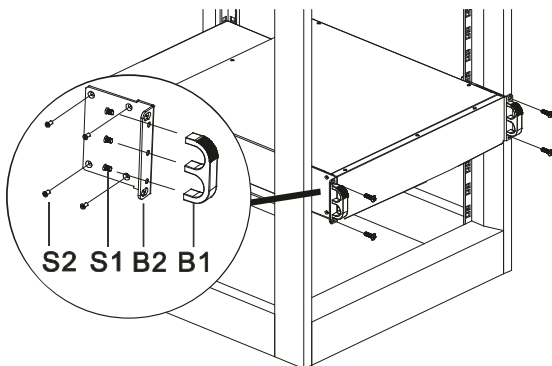

 The UPS must be installed always at the top of other equipment like battery cabinets.

 Do not transport the UPS or the battery cabinet by handles.

 The battery cabinet is heavy, so it must be installed from bottom to top of the rack cabinet and located below the UPS.

4.3 Electrical connection

The electrical connection is part of the work that is not performed by LEGRAND, and it is the sole responsibility of the Skilled Technician. Follow strictly the instructions provided in the installation manual of the UPS.

4.3.1 Wiring operation

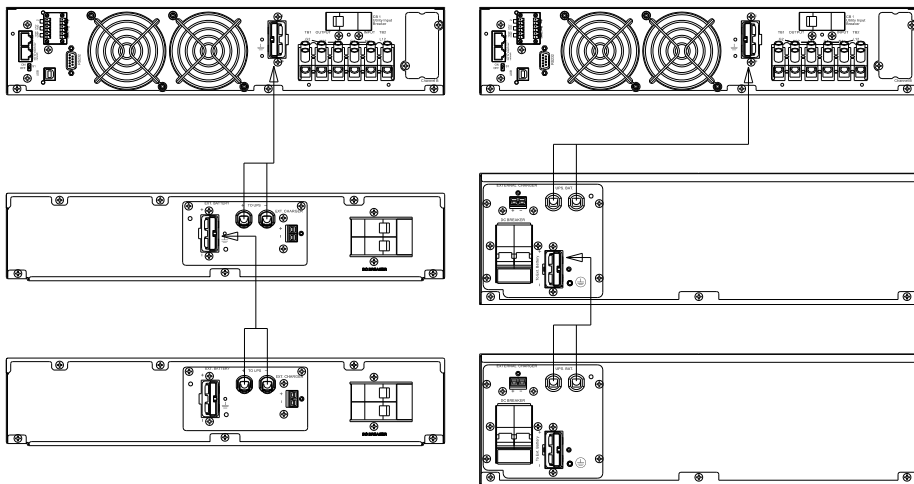

To connect the power cord cable:

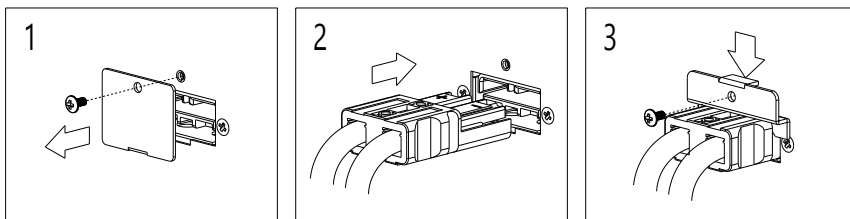

To connect the external battery charger connector:

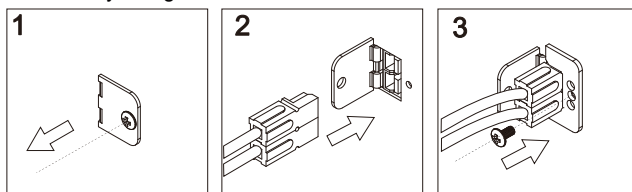

BATTERY CABINET KEOR DK R/T 5-6-10 kVA

To connect the temperature compensation connector:

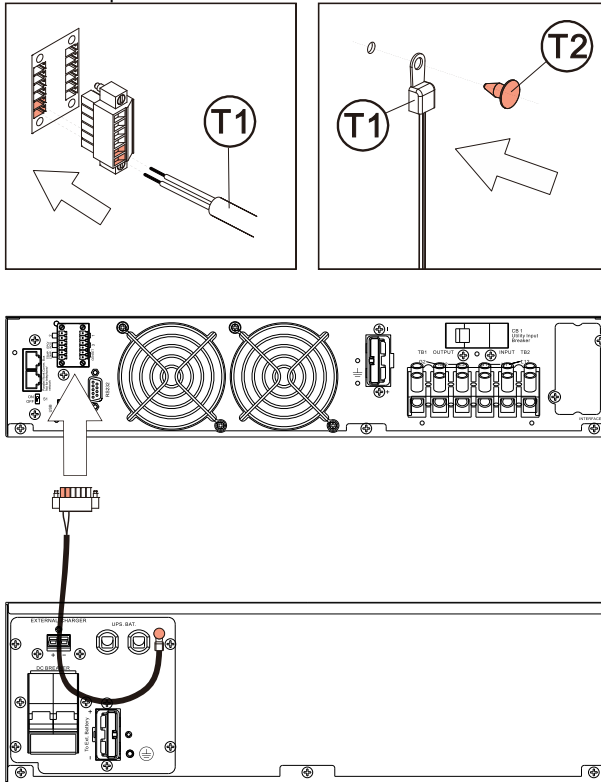

5. Maintenance



INSTALLATION and ORDINARY MAINTENANCE operations must be carried out only by SKILLED TECHNICIANS (paragraph 2.2.1). EXTRAORDINARY MAINTENANCE operations must be carried out only by LEGRAND TECHNICAL SUPPORT SERVICE.

LEGRAND declines all liability for any injury or damage caused by activities carried out differently from the instructions written in this manual.



Keep a register in which to enter the date, time, type and any other useful information about any routine and extraordinary maintenance operation.

5.1 Preventive maintenance

The EBC does not contain parts for preventative maintenance by the operator. The operator must regularly perform a general external cleaning.

5.2 Periodical checks

The correct functioning of the EBC must be guaranteed by periodical maintenance inspections. These are essential to safeguard the reliability of the equipment.

These inspections should also be made to determine if components, wiring, and connections exhibit evidence of overheating.

During a maintenance inspection, the skilled technician must carry out the following checks:

- integrity of the electrical installation.
- flow of cold air.
- battery status.
- conditions of the installation location.

Contact the LEGRAND Technical Support Service in case of problems.



The periodical checks involve operations inside the UPS in presence of dangerous voltages. Only maintenance personnel trained by LEGRAND are authorized to intervene.

5.3 Ordinary maintenance



Before carrying out any maintenance work, the EBC must be fully disconnected from the UPS



A battery may constitute a risk of electric shock and high short-circuit current. When working on batteries, the prescriptions indicated in chapter 2 must be adhered to.

5.3.1 EBC replacement

The battery cabinet is hot-swappable.

5.3.2 Battery replacement

- Battery cabinet for 5-6 kVA UPS

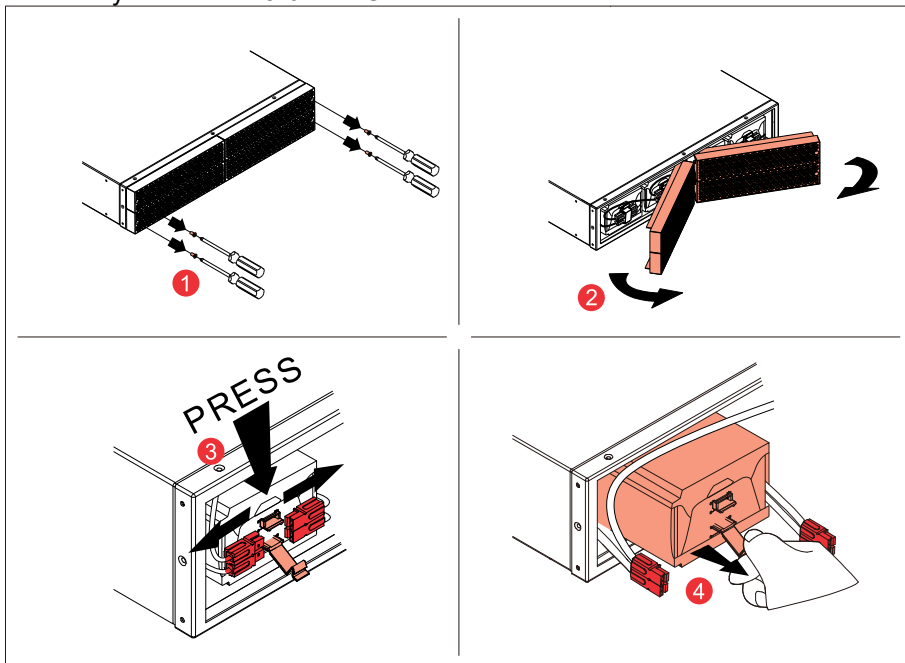

- Battery cabinet for 10 kVA UPS

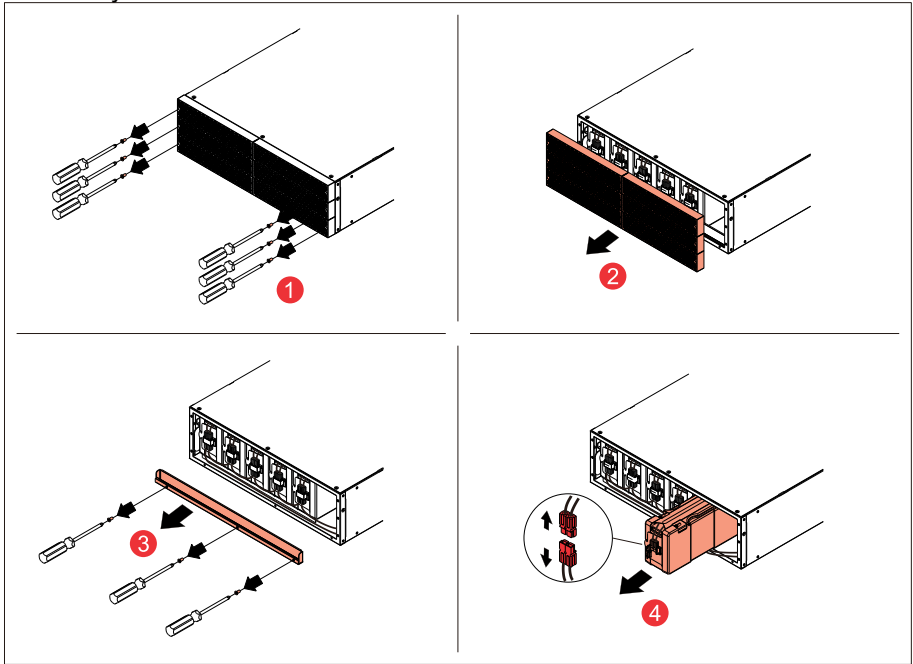

6. Warehousing



All storage operations must be carried out only by a **SKILLED TECHNICIAN** (paragraph 2.2.1)



A **SKILLED TECHNICIAN** must check that there is no voltage present before disconnecting the cables.

6.1 Batteries

It is possible to store batteries without recharging them in the following conditions:

- up to 6 months if the temperature is between +20°C (+68°F) and +30°C (+86°F);
- up to 3 months if the temperature is between +30°C (+86°F) and +40°C (+104°F);
- up to 2 months if the temperature is over +40°C (+104°F).



Batteries must never be stored if partially or totally discharged. LEGRAND is not liable for any damage or bad functioning caused to the UPS by wrong warehousing of the batteries.

7. Dismantling



Dismantling and disposal operations must be carried out only by a **SKILLED TECHNICIAN** (paragraph 2.2.1).

The instructions in this chapter are to be considered indicative: in every country there are different regulations regarding the disposal of electronic or hazardous waste such as batteries. It is necessary to strictly adhere to the regulations in force in the country where the equipment is used.

Do not throw any component of the equipment in the ordinary rubbish.

7.1 Battery disposal

Batteries must be disposed of in a site intended for the recovery of toxic waste. Disposal in the traditional rubbish is not allowed. Apply to the competent agencies in your countries for the proper procedure.



Pb



A battery may constitute a risk of electric shock and high short-circuit current. When working on batteries, the prescriptions indicated in chapter 2 must be adhered to.

7.2 Electronic component dismantling

For the disposal of electronic waste, it is necessary to refer to the relevant standards.



This symbol indicates that in order to prevent any negative effects on the environment and on people, this product should be disposed of separately from other household waste, by taking it to authorised collection centres, in accordance with the EU countries local waste disposal legislations. Disposing of the product without following local regulations may be punished by law. It is recommended to check that this equipment subject to WEEE legislations in the country where it is used.

8. Technical characteristics

MAIN FEATURES

	3 113 63 3 113 69	3 113 64 3 113 70
to be installed with UPS (item)	3 113 48 3 113 50 3 113 49 3 113 51	3 113 52

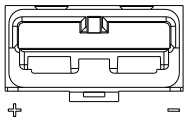
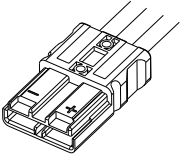
	3 113 63	3 113 64
Number of batteries	20	20
Number of battery packs	4 blocks of 5 batteries	5 blocks of 4 batteries
Battery type	Lead-acid sealed without maintenance (VRLA)	
Unitary voltage (V) and capacity (Ah)	12 Vdc – 5 Ah	12 Vdc – 9 Ah
Rated Battery Voltage (V)	240	
DC socket		
DC plug		

MECHANICAL CHARACTERISTICS

	3 113 63	3 113 64
Net weight (kg)	48.5	65.5
Dimensions H x W x D (mm)	88 (2U) x 440 x 680	132 (3U) x 440 x 700

	3 113 69	3 113 70
Net weight (kg)	12.5	13.5
Dimensions H x W x D (mm)	88 (2U) x 440 x 680	132 (3U) x 440 x 700

ENVIRONMENTAL CONDITIONS

	3 113 63 3 113 69	3 113 64 3 113 70
Operating temperature (°C)	0 to +40 (The battery life will reduce with the temperature >25 °C)	
Relative humidity during operation (%)	0 to 95 (non-condensing)	
Storage temperature (°C)	-10 to +50 (without batteries) -10 to +40 (with batteries) (The battery life will reduce with the temperature >25 °C)	
Ingress Protection Marking	IP 20	
Pollution degree	PD2	
Climatic class (EN IEC 60721-3-3)	3K22	
Special climatic class (EN IEC 60721-3-3)	3Z2	
Biological class (EN IEC 60721-3-3)	3B2	
Mechanical class (EN IEC 60721-3-3)	3M11	
Mechanically active substances class (EN IEC 60721-3-3)	3S5	
Operating height	up to 2000 metres above sea level without derating	

REFERENCE DIRECTIVES AND STANDARDS

Marks	CE, CMIM, UKCA
Safety	2014/35/EU Directive EN IEC 62040-1
EMC	2014/30/EU Directive EN IEC 62040-2

LEGRAND
Pro and Consumer Service
BP 30076 - 87002
LIMOGES CEDEX FRANCE
www.legrand.com

Installer stamp